

Targus®

MULTIMEDIA
PRESENTATION REMOTE

User Guide

Introduction

Thank you for your purchase of the Targus Multimedia Presentation Remote. This combination remote, with laser pointer and cursor control, works with both Microsoft PowerPoint® and Apple Keynote®. This cordless remote also offers true plug and play capability with no need for software drivers, while the long-range 2.4 GHz technology allows for effective presentations up to 50 feet (15 m).

Contents

- Targus Multimedia Presentation Remote
- Mini USB Receiver
- 2 x AAA Batteries
- User Guide

System Requirements

Hardware

- USB port

Operating System

- Microsoft Windows® 2000
- Microsoft Windows® XP
- Microsoft Windows Vista®
- Microsoft Windows® 7
- Mac OS® X 10.4 or later

Setting Up Your Remote Installing the Batteries

Press the battery cover release button to open the battery cover and carefully lift the cover as shown.

Battery cover
release button

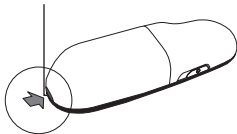

Battery
cover

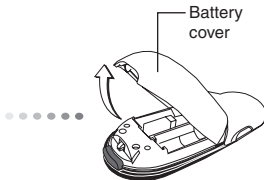

Insert the supplied batteries, making sure the positive (+) and negative (-) ends of the batteries match the polarity indicators inside the battery compartment.

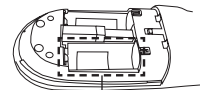
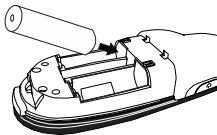

Spare battery compartment



NOTE: THE SPARE BATTERY COMPARTMENT PROVIDES CONVENIENT STORAGE FOR A SEPARATE BATTERY (INCLUDED) WHICH CAN BE USED FOR EMERGENCY POWER.

Remove the mini USB receiver stored inside the center compartment.

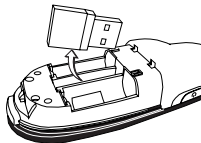

Slide the battery cover back into position until it “clicks” firmly into place.



Using Your Remote

Before using the remote, please select your computer type and preferred presentation software. Locate the switch inside the battery compartment as shown.

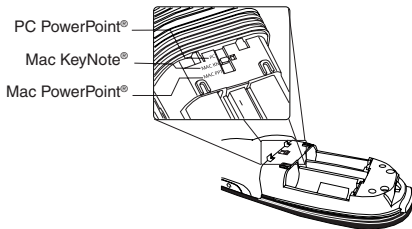

NOTE: SELECT "PC POWERPOINT" IF YOU USE A COMPUTER MADE BY: HP/COMPAQ, DELL, TOSHIBA, GATEWAY, PANASONIC, FUJITSU, SONY, IBM/LENOVO, ACER, ASUS, ETC.

This remote is a plug and play device. It will automatically operate when the USB receiver is connected to the computer. Plug the mini USB receiver into any available USB port on your computer.

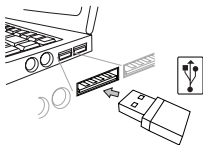

Turn on the remote by pressing and holding the On/Off power button for 3 seconds.

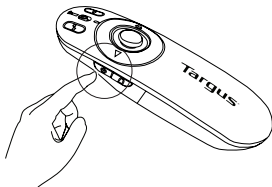

Keys and Functions

This device can function as a presenter or a wireless mouse by using the mode switch (12).

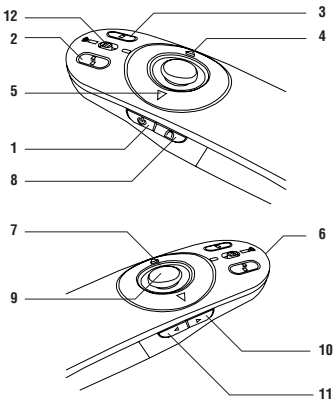

1	Power button	Press and hold for 3 seconds to turn on the remote. LED ring will turn green.
		Press and hold for 3 seconds to turn off the remote. LED ring will shut off.

Using the Device — Presenter Mode

2	Blank screen button	The screen will become blank/dark.
3	Slide show	Start - Press once to begin.
		Stop - Press and hold for 2 seconds to stop the slide show.
4	Page Forward/Next slide	Press once to go to next slide.
5	Page Backward/Previous slide	Press once to go back one slide.
6	Laser pointer	Laser light is emitted from the opening.
7	LED ring	Power and KeyLock™ indicator.
8	KeyLock button	Press once to enable KeyLock function. - Disables all keys except the laser, page forward/ next slide and page backward/previous slide buttons. - LED ring will become RED.
		Press once to exit the KeyLock function. - LED ring will return to GREEN.
9	Laser pointer button	Press and hold to activate the laser pointer.
10	Volume up button	Press to increase the volume.
11	Volume down button	Press to decrease the volume.

Using the Device — Mouse Mode

4	Right mouse click	Right mouse click.
5	Left mouse click	Left mouse click.
7	LED ring	Power indicator.
8	KeyLock button	Disabled in mouse mode.
9	Joystick	Pressing the joystick resembles left mouse click. Moves the mouse cursor.
10	Volume up button	Press to increase the volume.
11	Volume down button	Press to decrease the volume.

Safety Measures

- To avoid possible eye damage, never point the remote's laser at people, especially their faces, or look directly into the remote's laser beam.
- Avoid pointing the remote's laser beam at a mirror or other highly-reflective surface.
- Keep the remote away from young children.
- Never view the remote's laser beam using telescopic devices, such as a microscope or binoculars.
- Any attempt to disassemble, adjust or repair the remote may result in exposure to laser light or other safety hazards.

Troubleshooting

What do I do if the response time of the remote is slow or it intermittently stops working?

- Make sure that the remote is within 50 feet (15 m) of the mini USB receiver and computer.
- Increase the distance between the remote's receiver and the base units of other wireless devices.
- Turn off any wireless devices and their base units that are near the remote's receiver.
- Replace the battery.

Technical Support

For technical questions, please visit:

US

Internet: www.targus.com/support.asp

Australia

Internet: www.targus.com/au

Email: infoaust@targus.com

Telephone: 1800-641-645

New Zealand

Telephone: 0800-633-222

Product Registration

Targus recommends that you register your Targus accessory shortly after purchasing it. Go to:

<http://www.targus.com/registration.asp>

You will need to provide your full name, email address, country of residence and product information.

Warranty

Targus warrants this product to be free from defects in materials and workmanship for one year. If your Targus accessory is found to be defective within that time, we will promptly repair or replace it. This warranty does not cover accidental damage, wear and tear, or consequential or incidental loss. Under no conditions is Targus liable for loss of, or damage to devices; nor loss of, or damage to, programs, records, or data; nor any consequential or incidental damages, even if Targus has been informed of their possibility. This warranty does not affect your statutory rights.

Regulatory Compliance

This device complies with Part 15 of the FCC Rules. Operation is subject to the following two conditions: (1) This device may not cause harmful interference, and (2) This device must accept any interference received, including interference that may cause undesired operation.

FCC Statement

Tested to Comply

This equipment has been tested and found to comply with the limits of a Class B digital device, pursuant to Part 15 of the FCC Rules. These limits are designed to provide reasonable protection against harmful interference in a residential installation. This equipment generates, uses, and can radiate radio frequency energy and if not installed and used in accordance with the instructions, may cause harmful interference to radio communications. However, there is no guarantee that interference will not occur in a particular installation. If this equipment does cause harmful interference to radio or television reception, which can be determined by turning the equipment off and on, the user is encouraged to try to correct the interference by one or more of the following measures:

- Reorient or relocate the receiving antenna;
- Increase the separation between the equipment and receiver;
- Connect the equipment into an outlet on a circuit different from that to which the receiver is connected;
- Consult the dealer or an experienced radio/TV technician for help.

Changes or modifications not authorized by the party responsible for compliance could void the user's authority to operate this product.

Declaration of Conformity

Hereby, Targus, declares that this device is in compliance with the essential requirements and other relevant provisions of Directive 1999/5/EC.

Microsoft, Windows, and Windows Vista are either registered trademarks or trademarks of Microsoft Corporation in the United States and/or other countries. All trademarks and registered trademarks are the property of their respective owners. All rights reserved. Features and specifications are subject to change without notice. © 2009. Targus Group International, Inc. and Targus, Inc., Anaheim, CA 92806 USA



Complies with EN 60825-1: 1994+A1+A2
and Complies with 21 CFR 1040.10 and
1040.11 except for deviation pursuant to
Laser Notice No.50, dated July 26,2001.

AVOID EXPOSURE — HAZARDOUS ELECTROMAGNETIC RADIATION EMITTED FROM THIS APERTURE.

LASER RADIATION. DO NOT STARE INTO THE BEAM OR VIEW DIRECTLY WITH OPTICAL INSTRUMENTS. CLASS 2 LASER PRODUCT.

NEVER POINT A LASER BEAM INTO A PERSON'S EYES OR VIEW A LASER BEAM DIRECTLY, AS PROLONGED EXPOSURE CAN BE HAZARDOUS TO THE EYES. MOMENTARY EXPOSURE FROM A LASER POINTER, SUCH AS AN INADVERTENT SWEEP OF THE LIGHT ACROSS A PERSON'S EYES, MAY CAUSE TEMPORARY FLASH BLINDNESS SIMILAR TO THE EFFECT OF A CAMERA FLASH BULB. ALTHOUGH THIS CONDITION IS TEMPORARY, IT CAN BECOME MORE DANGEROUS IF THE EXPOSED PERSON IS ENGAGED IN A VISION-CRITICAL ACTIVITY SUCH AS DRIVING.

CAUTION: ANY CHANGES OR MODIFICATIONS NOT EXPRESSLY APPROVED BY THE PARTY RESPONSIBLE FOR COMPLIANCE COULD VOID THE USER'S AUTHORITY TO OPERATE THE EQUIPMENT.

THIS DEVICE AND ITS ANTENNA(S) MUST NOT BE CO-LOCATED OR OPERATING IN CONJUNCTION WITH ANY OTHER ANTENNA OR TRANSMITTER. YOUR DEVICE CONTAINS A LOW POWER TRANSMITTER. WHEN DEVICE IS TRANSMITTED IT SENDS OUT RADIO FREQUENCY (RF) SIGNAL. ***NOTE: THE MANUFACTURER IS NOT RESPONSIBLE FOR ANY RADIO OR TV INTERFERENCE CAUSED BY UNAUTHORIZED MODIFICATIONS TO THIS EQUIPMENT. SUCH MODIFICATIONS COULD VOID THE USER'S AUTHORITY TO OPERATE THE EQUIPMENT.***

1 YEAR LIMITED WARRANTY: We pride ourselves on the quality of our products. For complete warranty details and a list of our worldwide offices, please visit www.targus.com. Features and specifications are subject to change without notice. Microsoft, Windows, Windows Vista, PowerPoint and Windows Media Player are registered trademarks or trademarks of Microsoft Corporation in the United States and/or other countries. Mac, Keynote and iTunes are all registered trademarks of Apple Inc., registered in the U.S. and other countries. All trademarks and registered trademarks are the property of their respective owners. ©2009 Targus Group International, Inc.

